

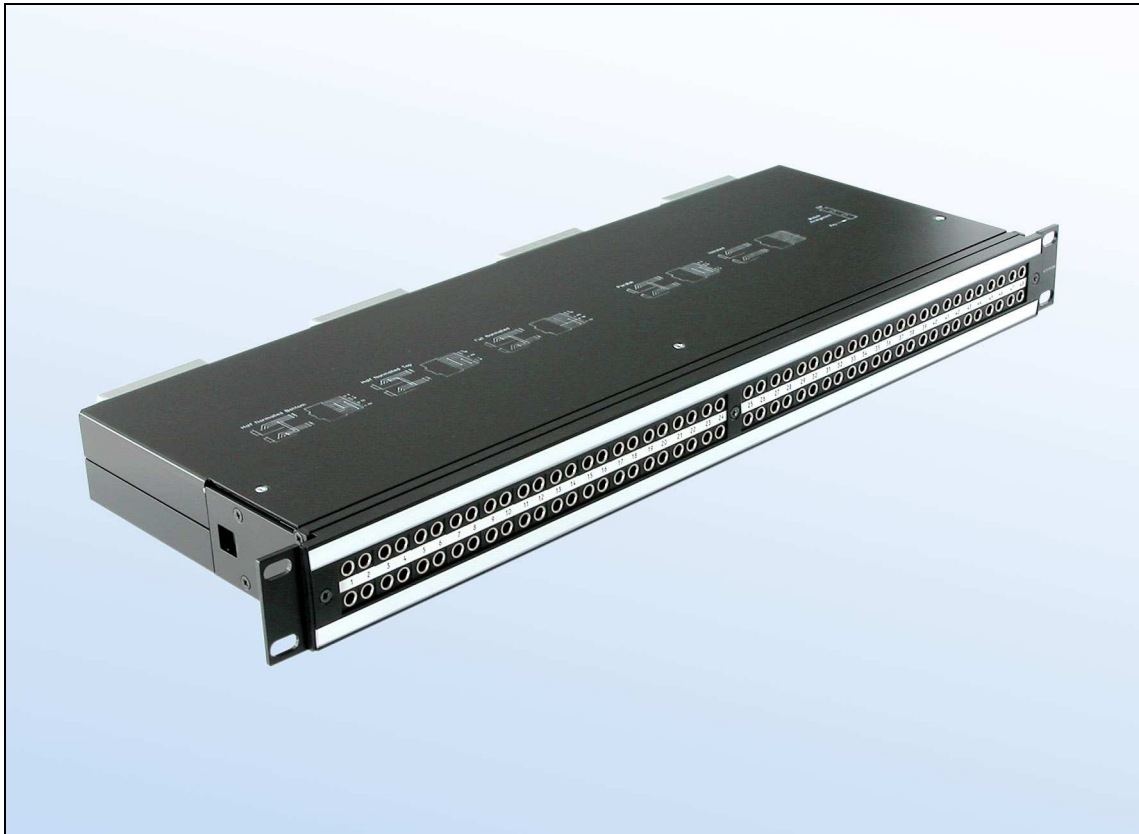

INSTRUCTION MANUAL

NPPA-TT-E90

PATCH PANEL | 96 Bantam (TT) Jacks,
EDAC 90-pin termination



NEUTRIK AG
Liechtenstein

Tel.: +423/237 24 24
Fax: +423/232 53 93
www.neutrik.com

NEUTRIK Zürich AG
Switzerland

Tel.: +41 44/736 5010
Fax: +41 44/736 5011

NEUTRIK (UK) Ltd.
Great Britain

Tel.: +44 1983/811 441
Fax: +44 1983/811 439

NEUTRIK USA INC.
USA

Tel.: +1 732/901 9488
Fax: +1 732/901 9608

NEUTRIK Tokyo Ltd.
Japan

Tel.: +81 3/3663 4733
Fax: +81 3/3663 4796

NEUTRIK France
France

Tel.: +33 1/4131 6750
Fax: +33 1/4131 0511

NEUTRIK Vertriebs GmbH
Germany/Netherlands/Austria

Tel.: +49 8131/28 08 90
Fax: +49 8131/28 08-30

Draft. Nr.: BDA90-1/3102M0801
Update: 03.08.2009

Data subject to change without prior notice. ©2007 NEUTRIK . ALL RIGHTS RESERVED.

NEUTRIK



Index

- 1. Electrical configuration.....3
- 2. Replacement of Jack Pairs4
- 3. Reconfiguration by hand.....5
- 4. Grounding variations6
- 5. Wiring diagram8
- 6. Cable retention to the unit.....10
- 7. Channel identification10
- 8. Technical data13
- 9. Ordering Information.....14

Dimensional Drawings "Easy Patch" NPPA-TT-E90

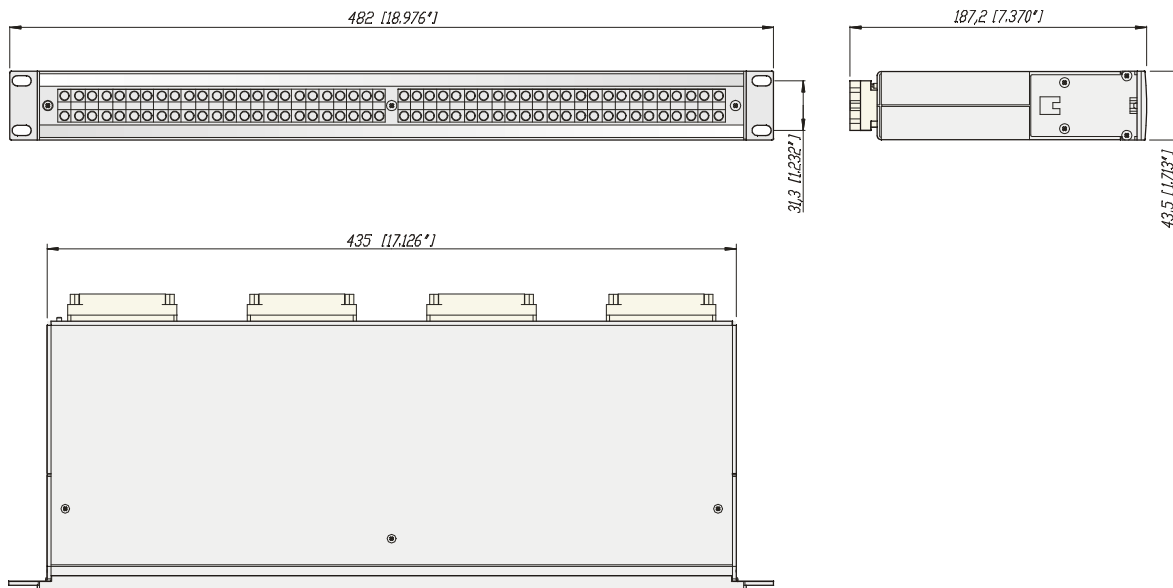



1. Electrical configuration

The Neutrik "Easy Patch" Patch Panel is fitted with high quality, long life NJ3TTA gold plated double contact jacks (2 x 48). This Patch Panel is an innovative and compact patching system (just 1 U high) for 19" rack mounting. Robustly housed in black coated steel shell and featuring precision aluminum fittings it is built to last. The Neutrik "Easy Patch" is suitable for analog and digital audio signals.

The "Easy Patch" is available in five normalling configurations (fully loaded).

- half normalled bottom row
- half normalled top row
- full normalled
- parallel
- isolated

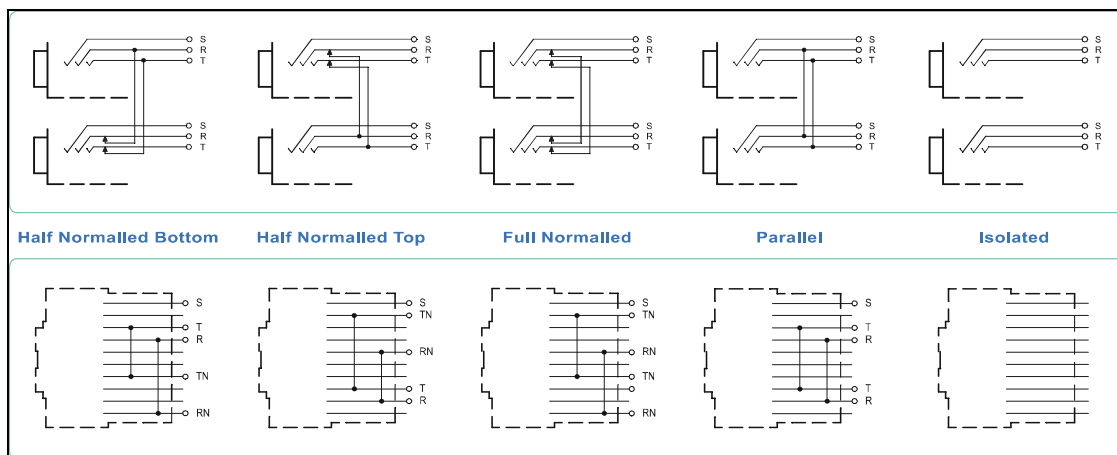

Configuration Chart

Furthermore individual jack pairs can be changed to combine various normallings within one panel quickly and without fuss. This is even possible while the panel is "on air". For this we offer pre-configured jack pairs (NJ3TTA-4-*).

In case of emergency the normalling for individual jack pairs can be changed by the use of normalling bars. Normalling bars to change the normalling of 4 channels are included.



2. Replacement of Jack Pairs

Each individual jack pair can be exchanged quickly and without fuss even while the panel is "on air". For replacement simply remove the easy accessible jack pairs.



Module consisting of 2 Jack Pairs



Remove Front Panel by unscrewing the 3 black cross-recessed screws (M3x8 Taptite), remove the two side-stops.

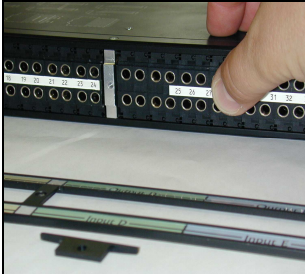

Push out the channel identification strips.

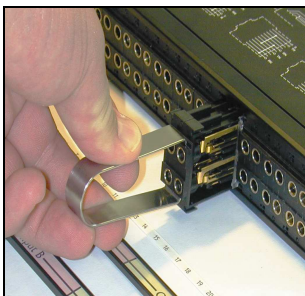

Pull one module out of the casing using the supplied disassembling pliers

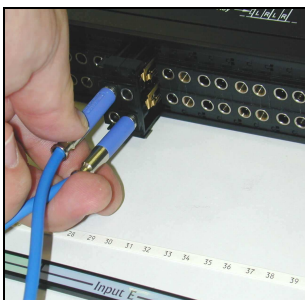

Alternatively the jack pairs may be pulled out by the use of two Bantam plugs (diagonally plugged in).

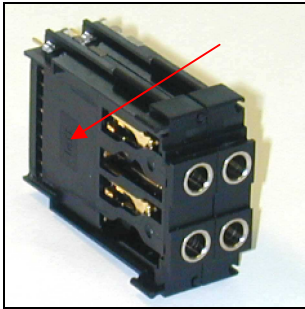

The two jack pairs have to be re-assembled in the right way so that the thicker body marked "left" is put on the left side with the mark outside and readable.

To complete, push the new jack pairs into the casing again with the mark on the left side (If more than one module are removed always assemble from the center to the right or left side and be careful that the keys on the left side of the jack pairs find their guiding slots. If all jack pairs are removed start at the casing support in the center and assemble to the right and left side). Slide in again the channel identification strips (best from the outside inwards) and fix the front panel with the black cross-recessed screws. Don't forget to insert the side-stops before fixing the screws (see page 10).

3. Reconfiguration by hand

Please note, in case of emergency the normalling can be changed by hand by the use of normalling bars. For easy and safe modification work we recommend our preconfigured jack pairs (NJ3TTA-4-*).

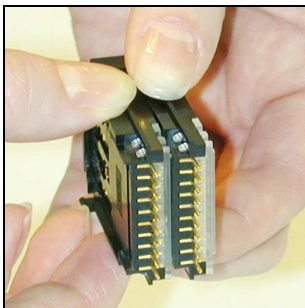

The two jack pairs are separated by spreading apart the rear parts to unlock the fixing mechanism till it is possible...

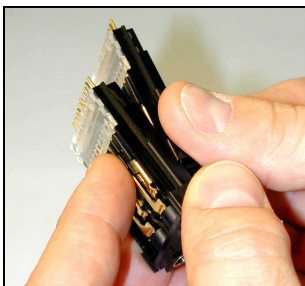

...to slide the jack pairs against each other in axial direction.

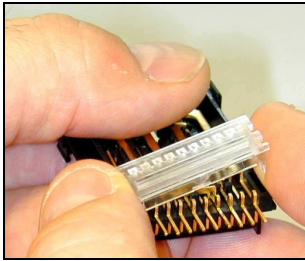

Then remove the cover with a tiny grip at the side and carefully

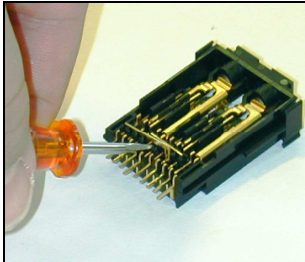

Pull out the configuration bars you need to exchange (preferably using a small screw-driver).

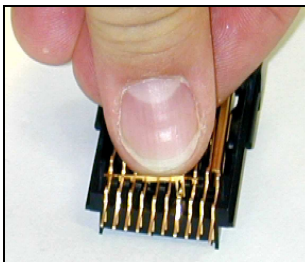

Insert new bars carefully by pressing them in parallel at both ends.

Attention: To ensure best contact conditions never reuse the configuration bars once being put in place! Always take new ones! Keep the contacts and switches in place with the thumb while manipulating the normalling contacts.

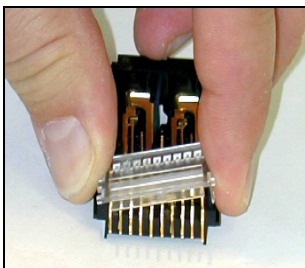

Finally snap on the cover (Insert it first at one side and then snap slightly into the opposite groove with a light pressure on the nose).

4. Grounding variations

The flexible grounding system provides the following versions:

- Individual:** Each channel is individually grounded by its corresponding cable shield (default configuration).
- Group:** Selected channel grounds are connected via the ground bus on the PCB using solder bridges and track cuts to form a group that is connected to one common cable shield.
- Central:** All channel grounds (individual top and bottom row) are connected via the ground bus on the PCB using solder bridges and wired with only one cable shield.
- Chassis-Common:** The same as central grounding but with the addition of the common ground bus (top and / or bottom rows) connected to the patch panel chassis by means of jumpers.

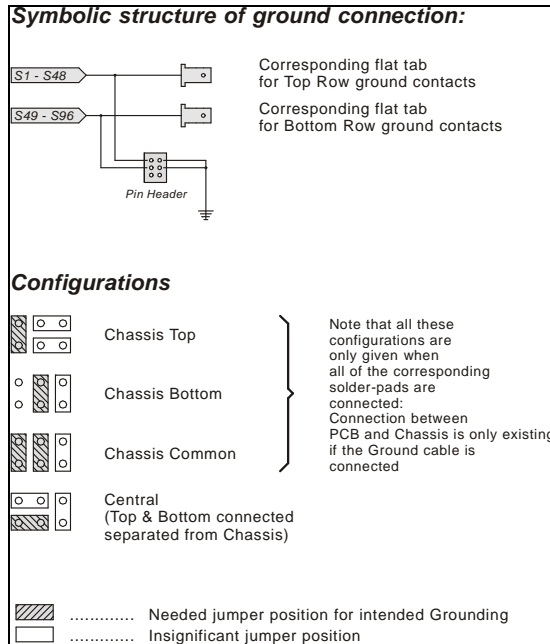

NOTE: In standard configuration there is no ground connection between top and bottom row unless it is provided by an inserted patch cable. If this is required, as in the case of phantom powered microphone lines, either make an internal connection by individually wiring the corresponding upper and lower 'S' terminals, or if the latter is critical with respect to possible ground loops make the connection via patch cable instead of using the normalling feature.



5. Wiring diagram

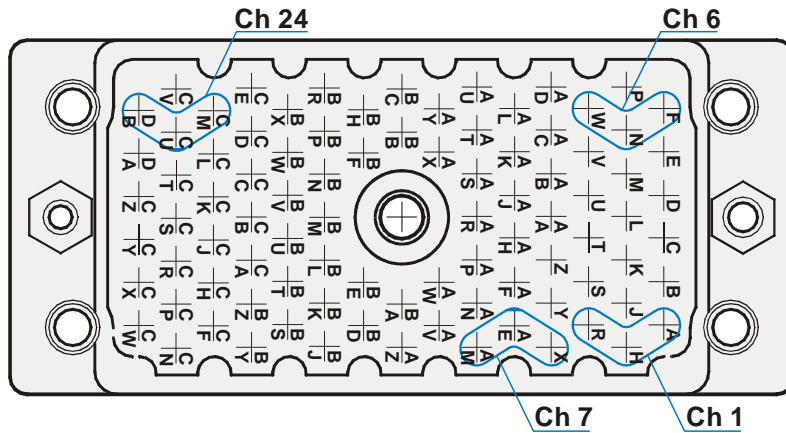

90 pole EDAC male (mating side)



Bottom Row 25-48 Top Row 25-48 Bottom Row 1-24 Top Row 1-24

Panel rear view

Channel No.	Tip (+)	Ring (-)	Sleeve (GND)
1 (25)	A	H	R
2 (26)	B	J	S
3 (27)	C	K	T
4 (28)	D	L	U
5 (29)	E	M	V
6 (30)	F	N	W
7 (31)	X	AE	AM
8 (32)	Y	AF	AN
9 (33)	Z	AH	AP
10 (34)	AA	AJ	AR
11 (35)	AB	AK	AS
12 (36)	AC	AL	AT
13 (37)	BJ	BS	BY
14 (38)	BK	BT	BZ
15 (39)	BL	BU	CA
16 (40)	BM	BV	CB
17 (41)	BN	BW	CC
18 (42)	BP	BX	CD
19 (43)	CF	CN	CW
20 (44)	CH	CP	CX
21 (45)	CJ	CR	CY
22 (46)	CK	CS	CZ
23 (47)	CL	CT	DA
24 (48)	CM	CU	DB



NPPA-TT-E90 Instruction Manual

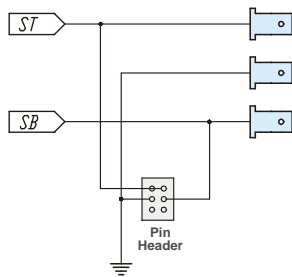
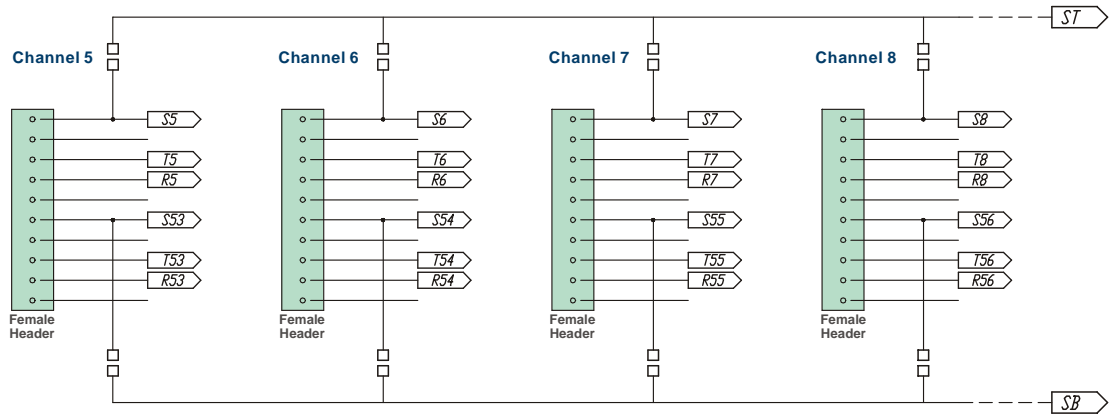
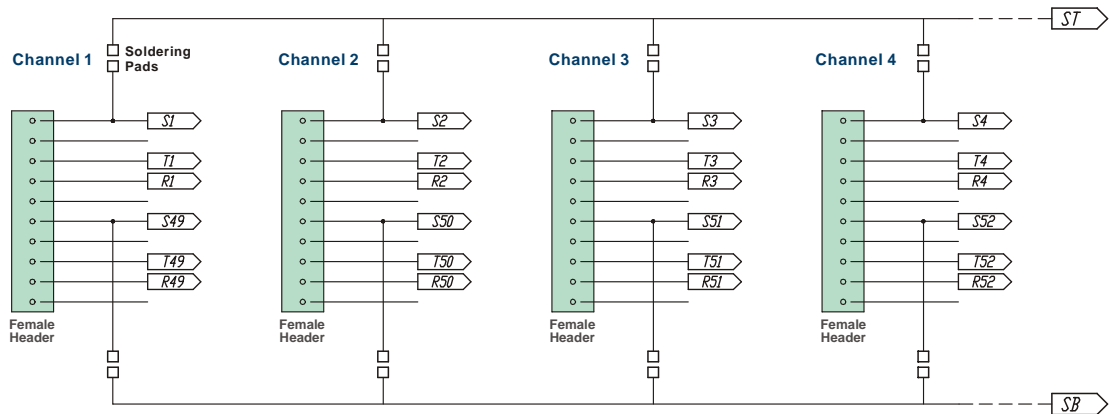



6. Cable retention to the unit

The ELCO®-EDAC® 90 connector is fixed to the housing by means of 4 screws. The plug itself is secured by one screw.

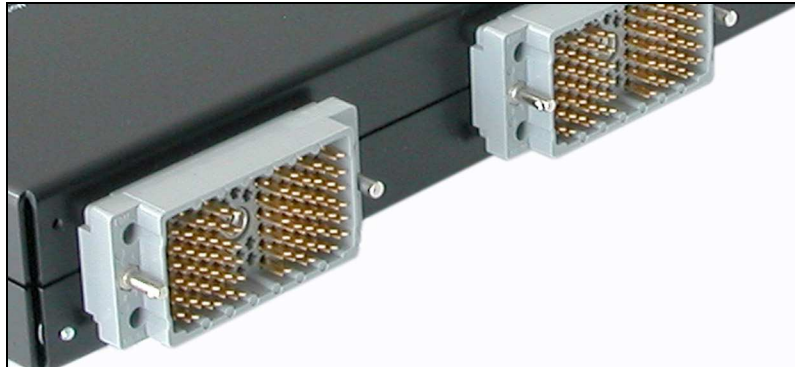

The built in cable retention bar is at the back of the casing. Simply attach the cables with cable ties to the bar as shown in the photo.



Cable Retention Bar

7. Channel identification

The front panel is equipped with **channel identification strips** located in the center of the channels and marked with the channel numbers 1-24 and 25-48 respectively.



NPPA-TT-E90 Instruction Manual

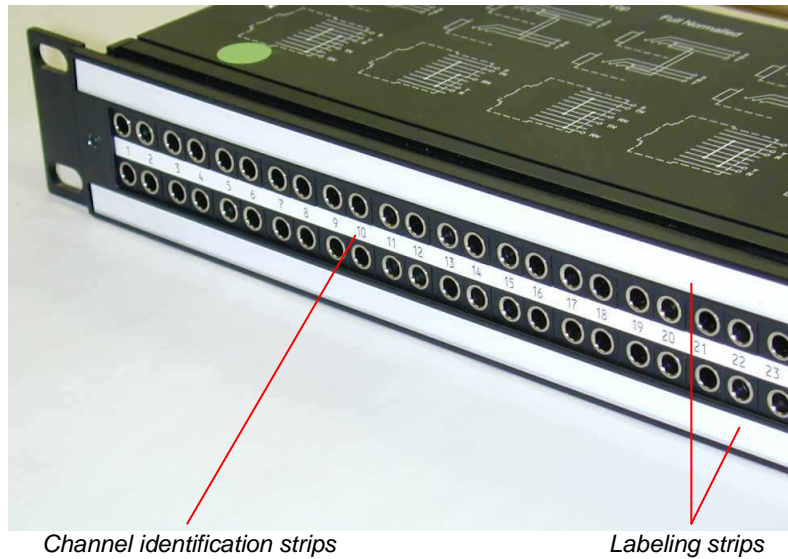

For the perfect management of the system and for individual identification according to customer's needs there are two large and separate labeling strips, one for the bottom and one for the top row.

To write on the paper you have to unscrew one of the outer fixing screws of the front panel. Then pull out the side-stop, the transparent foil and the paper strip itself. After marking is done assemble the parts in reversed sequence.

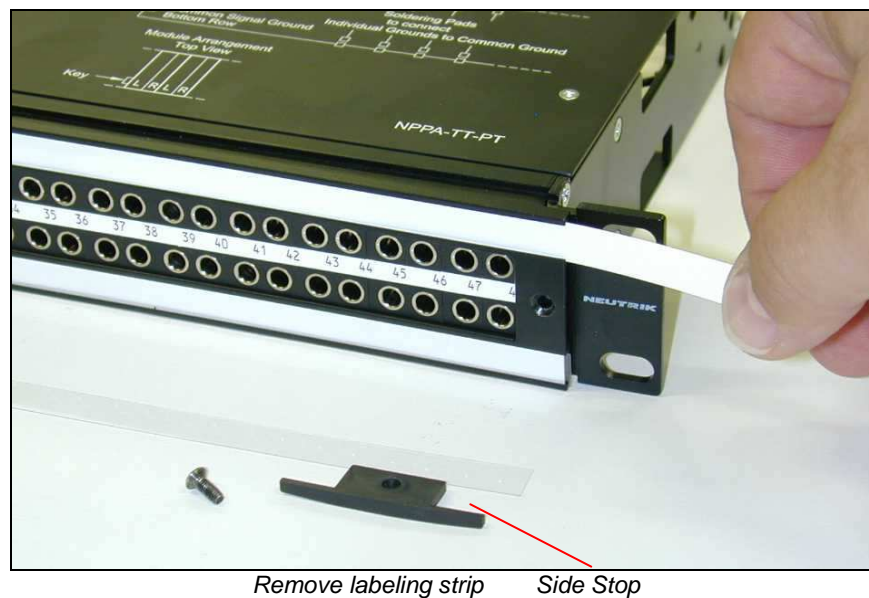

NOTE: For easy and perfect marking you can use our designation software “PatchLabel” which is available on our web site www.neutrik.com free of charge.

Print-Out software “Patch Label”



NPPA-TT-E90 Instruction Manual

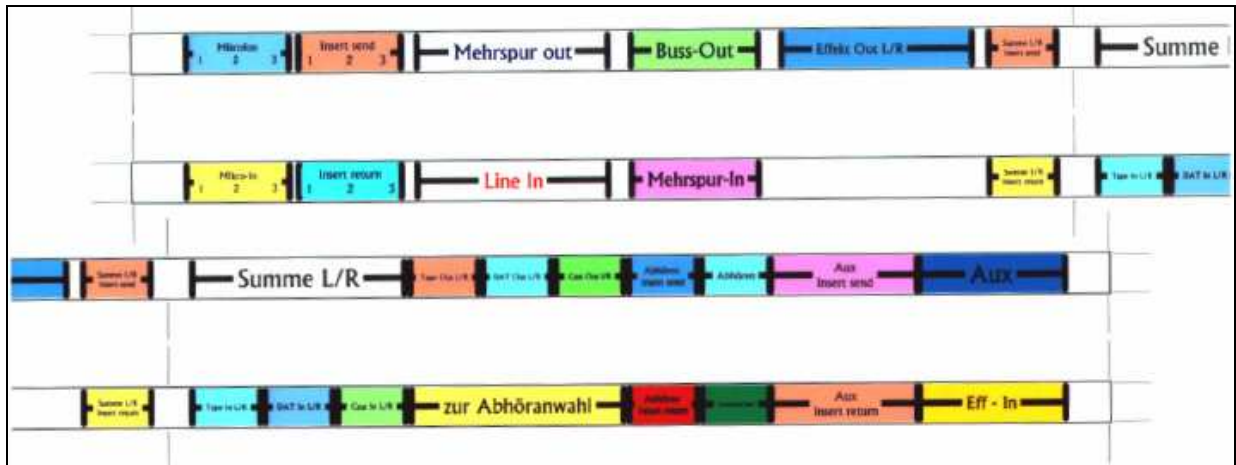



8. Technical data

8.1 Electrical

Frequency range:	DC to > 50 MHz
Digital suitability:	Digital audio acc. to AES/EBU
Channel separation:	> 100 dB @ 10 kHz, 600 Ω terminated > 40 dB @ 6 MHz, 110 Ω terminated
Insulation resistance:	> 10^9 Ω @ 500 V dc
Connector contact resistance:	< 20 m Ω
Switch contact resistance:	< 25 m Ω
Dielectric strength:	1000 V dc

7.2 Mechanical

Lifetime:	> 5.000 Insertion / withdrawal cycles
Insertion / Withdrawal force:	< 10 N / > 8 N
Cable retention force:	70 N max per cable retention bar
Dimensions (rack mount):	482 mm (W) \times 44 mm (H) (19" \times 1 U)
Depth:	89 mm (3.5")
Weight:	2.1 kg
Temperature range:	- 30°C to +80°C

7.3 Materials

Jack housing:	PA 66 blend
Jack contacts:	CuSn6 – TRIBOR [®] plated (0.2 μ m AuCo over 2 μ m NiP)
Casing:	Steel and aluminum, black coated
Front Panel:	AlMgSi 0.5 F22



9. Ordering Information

Standard supply

The compact Neutrik "Easy Patch" NPPA-TT-E90 consists of:

- Black coated steel casing with aluminum fittings
- 2 x 48 highly integrated Neutrik NJ3TTA jacks with gold plated double contacts and specially designed normalling mechanism (standard: half normalled bottom row)
- Integrated internal pre-wiring with selectable flexible grounding system
- 4 ELCO®-EDAC® 90-pin male connectors
- Chassis integrated cable retention
- Spare normalling configuration bars
 - 4 Normal 1 : "short", bridges 5 contacts
 - 8 Normal 2 : "medium", bridges 6 contacts
 - 4 Normal 3 : "long" , bridges 7 contacts
- 1 Disassembling pliers
- 1 Instruction Manual

Options and Accessories

Pre-configured Jack-Pairs

Part Number	Description	Configuration*	
NJ3TTA-4-HNB	blocks of 2 channels	half normalled bottom row	cover ident color: clear
NJ3TTA-4-HNT	blocks of 2 channels	half normalled top row	cover ident color: yellow
NJ3TTA-4-FN	blocks of 2 channels	full normalled	cover ident color: green
NJ3TTA-4-P	blocks of 2 channels	parallel	cover ident color: red
NJ3TTA-4-I	blocks of 2 channels	isolated	cover ident color: orange

Accessories

NPPA-S	Strain Relief bar
NKTT*	Patch cords with NP3TT-1 plugs. Available in black, blue, green, red and yellow. Lenght: 30, 40, 60, 90, 120 cm
NPPA-NB	Normalling bars for changing the normalling of all 48 channels